

Inductive Proximity Sensors (DC Cylindric Sizes)

IK3MD0815

8 (PNP NC)

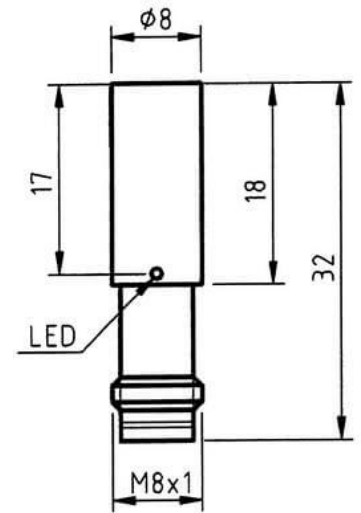

Connection:	plug M8, 3-pin
Connection type:	plug M8
Outlet:	PNP NC
Design:	8
Diameter:	8
Installation type:	flush
Short protection:	yes
Length:	32 mm
LED:	yes
No-load current:	10 mA
Nominal voltage:	24 VDC
Reproducibility:	1 %
Switching distance:	3 mm
Switching frequency:	2000 Hz
Switching hysteresis:	15 %
Protection class:	IP 67
Voltage drop:	2 V
Voltage type:	VDC
Voltage range:	10 - 30 V
Ampacity:	200 mA
Temperature drift:	10 °C
Environment temperature:	-25 bis 70 °C
Material:	stainless steel

Further information about this product can be found on our website, please visit:
https://schoenbuch-sensor.de/en/products/ik3md0814_en/ik3md0815_en/