

Inductive Proximity Sensors (Ring Initiators DC)

IR8MI1019

ring initiator 100 (NPN NO NC)

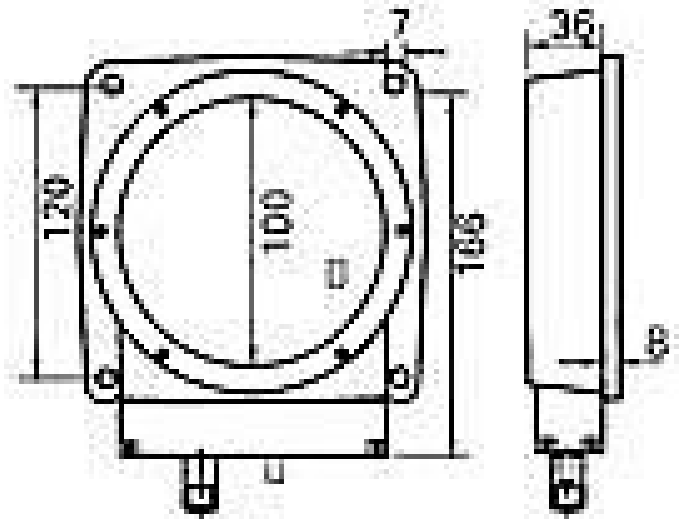

Connection:	plug M12
Connection type:	plug M12
Outlet:	NPN NO NC
Design:	Ringinitiator 100
Diameter:	100
Installation type:	non flush
Short protection:	yes
Length:	166 mm
No-load current:	15 mA
Nominal voltage:	24 VDC
Switching distance:	8 mm
Switching frequency:	500 Hz
Protection class:	IP 54
Voltage drop:	2,4 V
Voltage type:	VDC
Voltage range:	18 - 30 V
Ampacity:	200 mA
Environment temperature:	-25 bis 70 °C
Material:	Aluminium

Further information about this product can be found on our website, please visit:

https://schoenbuch-sensor.de/en/products/ir8mi1020_en/ir8mi1019_en/