

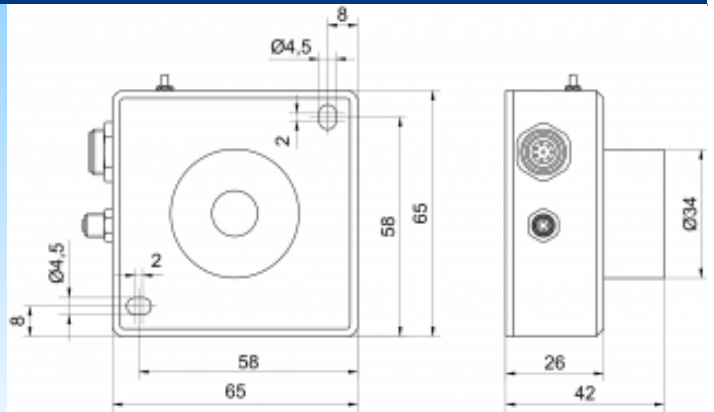

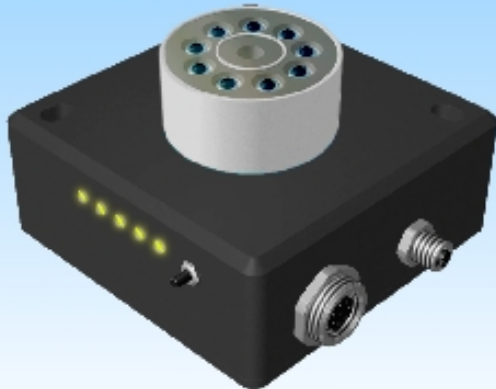

[Article Page](#)

Product Description

color sensor



Name	SPECTRO-3-30-DIL-CL
Order number	08386249643
Switch type	 digital
Signal Type	PNP/NPN
Illuminant	 White light
Connection	 Socket

Polschema

SPS
Binder 712, 8 pol.

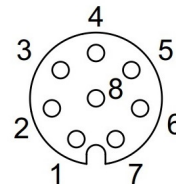

- 1 wh GND (0V)
- 2 bn +24V DC (±10%)
- 3 gn IN 0
- 4 ye OUT 0
- 5 gy OUT 1
- 6 pk OUT 2
- 7 bu OUT 3
- 8 rd OUT 4

PC
Binder 707, 4 pol.

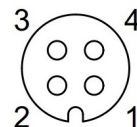

- 1 +24V DC
- 2 GND (0V)
- 3 RxD
- 4 TxD

Dimension (in mm)

Q 65 x 26 (+16) x 65

Technical Specification

Special features	Reduction of gloss effect due to diffuse illumination, Color and gray scale detection
Operating voltage	22,60 - 26,40 V DC
Max. load current	100 mA
No load current	320 mA
Switching frequency	30 kHz
Temperature drift	< 0,01 %/ °C
Repeat accuracy	+/- 1 Digit in the X, Y color range at 12-bit A/D conversion
Switching state	LED
Digital output	OUT 0 ... OUT 4, digital (0V/+Ub), 100 mA max. switching current npn, pnp-output available (bright-, dark-switching can be switched over)
Natural extraneous light	5000 Lux in AC-mode
Artificial extraneous light	5000 Lux in AC-mode
Material of light outlet	Glas
Impulse delay	einstellbar/ adjustable 0 ms ... 100 ms
Amplifying adjustable	8 fach/ 8-fold
Tolerance limit adjustable	ja
Working range	from 10 to 60 mm
Short-circuit proof	yes
Overload protection	yes
Reverse voltage protection	yes
Protection category	IP64 (Optik IP67)
EMC-level	DIN EN 60947-5-2
Housing material	Aluminum
Termination	connection to PLC: 8-pole fem. connector (Binder Series 712), connection to PC: 4-pole fem. connector (Binder Series 707)

Errors and omissions exceptet