

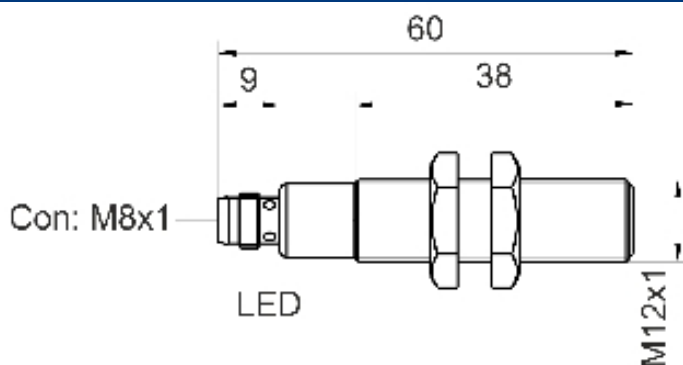

[Article Page](#)

Product Description

inductive sensor DC



Name	KJ2-M12MB60-DPÖ-V1
Order number	08317624464
Matchcode	9962-4464
Switching distance	2 mm
Mounting	 shielded
Switch type	 N.C.
Signal Type	DC PNP
Connection	connector M8

Connection diagramm

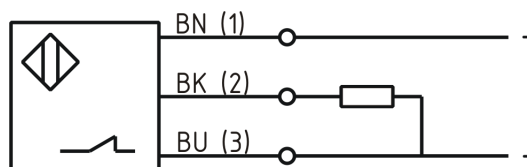

Dimension (in mm)	fine-pitch thread M12 x 60
-------------------	----------------------------

Technical Specification

Operating voltage	10 - 30 VDC
Max. ripple	≤ 10 %
Voltage drop	2,4 V
Max. load current	200 mA
No load current	≤ 13 mA
Leakage current	≤ 10 μA
Switching frequency	1000
Switching hysteresis	≤ 15 %
Operating temperature	-25 ° C to 70 ° C

Temperature drift	≤ 10 %
Repeat accuracy	≤ 10 %
Swiching state	LED
Short-circuit proof	yes
Overload protection	yes
Reverse voltage protection	yes
Protection category	IP67
EMC-level	DIN EN 60947-5-2:2008
Material active face	PA 6.6
Termination	Connector M8 3pin
FIT / MTTF	61,89 / 1844y

Errors and omissions exceptet