



[Article Page](#)

Product Description **fork light barrier**

Name	KOEG80-Q55ZB-DPU-V1-RT
Order number	08363533080
Switch type	 Switchable
Signal Type	DC PNP
Illuminant	 Red light
Connection	 Connector

Connection diagramm

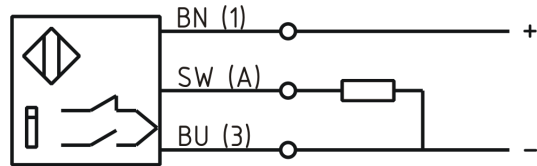

Dimension (in mm)	100 x 10 x 89
art_gewicht	125

Technical Specification

Signal type	Throughbeam sensor
Operating voltage	10 - 30 V DC
Max. load current	100 mA
Switching frequency	3
Operating temperature	-20 ° C to 60 ° C
Repeat accuracy	0,05 mm
Swiching state	LED
Digital output	
Natural extraneous light	100000 Lux
Artificial extraneous light	100000 Lux
Material of light outlet	Glas
Sensitivity adjustable	ja
Short-circuit proof	yes
Protection category	IP67
EMC-level	DIN EN 60947-5-2:2008
Housing material	Die-cast zinc
Termination	Connector M8 3pol

Errors and omissions exceptet