

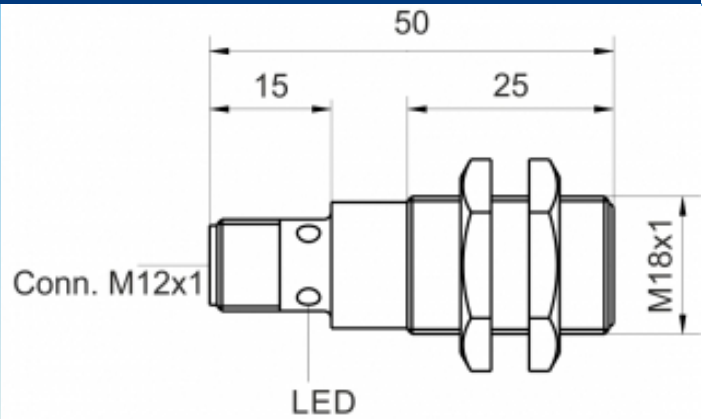

[Article Page](#)

Product Description

inductive sensor DC



Name	KJ5-M18MB50-DNS-V2
Order number	08317842165
Matchcode	9984-2165
Switching distance	5 mm
Mounting	 shielded
Switch type	 N.O.
Signal Type	DC NPN
Connection	connector M12

Connection diagramm

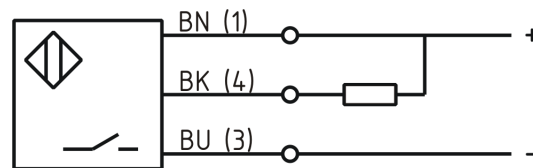

Dimension (in mm)	fine-pitch thread M18 x 50
-------------------	----------------------------

Technical Specification

Operating voltage	10 - 30 VDC
Max. ripple	≤ 10 %
Voltage drop	2,4 V
Max. load current	200 mA
No load current	≤ 13 mA
Leakage current	≤ 10 μA
Switching frequency	800 Hz
Switching hysteresis	≤ 15 %
Operating temperature	-25 ° C to 70 ° C

Temperature drift	≤ 10 %
Repeat accuracy	≤ 10 %
Swiching state	LED
Short-circuit proof	yes
Overload protection	yes
Reverse voltage protection	yes
Protection category	IP67
EMC-level	DIN EN 60947-5-2: 2008
Housing material	Brass, nickel plated
Material active face	Schulamid
Utilisation category	DC 13
Termination	Connector M12 4pin

Errors and omissions exceptet