

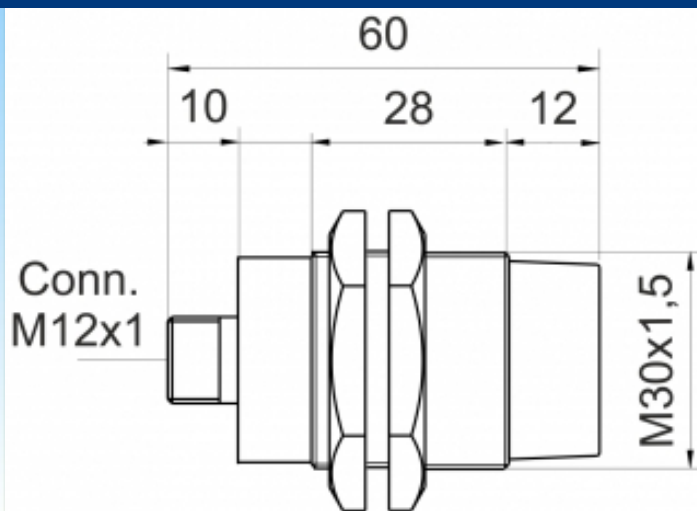

[Article Page](#)

Product Description

inductive sensor NAMUR

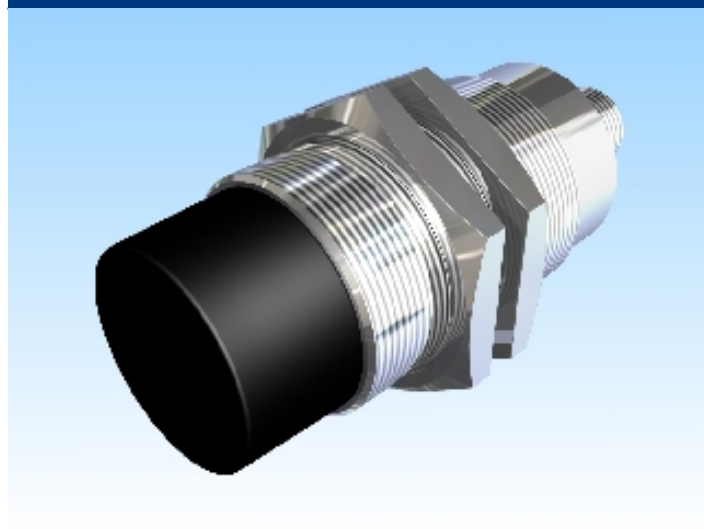

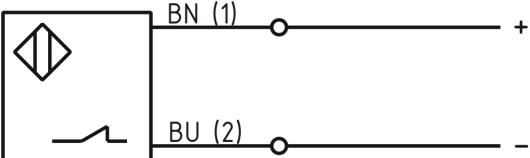
Name	KJ15-M30MN60-NA-V2
Order number	08317320865
Matchcode	9932-0865
Switching distance	15 mm
Mounting	 non shielded
Signal Type	Namur
Connection	connector M12
Connection diagramm	

Dimension (in mm)	fine-pitch thread M30 x 60
-------------------	----------------------------

Technical Specification

Operating voltage	6 - 12 V DC
Max. ripple	≤ 5 %
No load current	≤ 3,5 mA
Switching frequency	300 Hz
Operating temperature	-25 ° C to 60 ° C
Temperature drift	≤ 10 %
Repeat accuracy	≤ 10 %
Time delay	300 ms
Short-circuit proof	yes
Overload protection	yes
Reverse voltage protection	yes

Protection category	IP67
EMC-level	DIN EN 60947-5-6:2000-12
Housing material	Brass, nickel plated
Material active face	PCB
Utilisation category	DC 13
Contact material	CuSn
Contact surface material	NiAu
Contact holder	Pa 6
Nominal operating voltage	8,2 V DC
Termination	Connector M12 4pin
Load Current OFF	ca. 0,5 mA
Load Current ON	ca. 3,5 mA
FIT / MTTF acc. to SIEMENS 29500	17,38 / 6568y

Errors and omissions exceptet