



[Article Page](#)

Product Description **fork light barrier**

Name	KOEG60-Q55AB-DPU-V1-RT
Order number	08363333060
Switch type	 Switchable
Signal Type	DC PNP
Illuminant	 Red light
Connection	 Connector

Connection diagramm

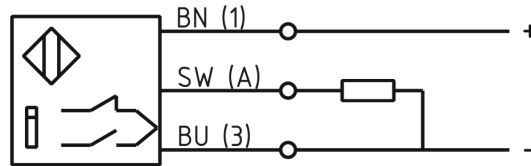

Dimension (in mm)	90 x 10 x 70
-------------------	--------------

Technical Specification

Signal type	Throughbeam sensor
Operating voltage	10 - 35 V DC
Max. load current	200 mA
No load current	< 30 mA
Switching frequency	2,5
Operating temperature	-10 ° C to 60 ° C
Repeat accuracy	0,01 mm
Swiching state	LED
Digital output	
Natural extraneous light	50000 Lux
Artificial extraneous light	50000 Lux
Material of light outlet	Glas
Sensitivity adjustable	ja
Short-circuit proof	yes
Protection category	IP67
Housing material	Aluminum
Termination	Connector M8 3pol

Errors and omissions exceptet