

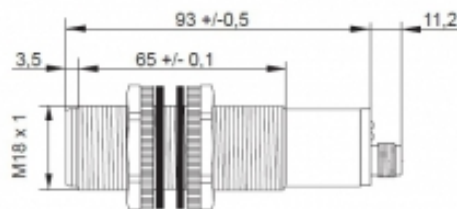

[Article Page](#)

Product Description

ultrasonic sensor



Name	KURT500-M18KB93-ANU-V2
Order number	08400830263
Matchcode	9983-0263
Switch type	 analog
Signal Type	Analog Voltage
Connection	 Connector

Connection diagramm

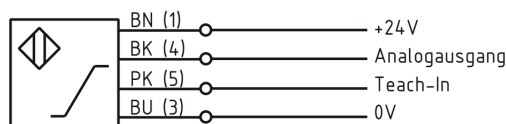

Dimension (in mm)	M18 x 93
-------------------	----------

Technical Specification

Signal type	Taster
Operating voltage	15 - 30 VDC
No load current	< 40 mA
Operating temperature	-15 ° C to 70 ° C
Repeat accuracy	+/- 0,2% / +/- 1 mm
Linearity	< 0,3 %
Operating state	LED
Analog output	Pulso_has10-10V
Time delay	100 ms
Carrier frequency	330 kHz
Sound beam	ca. 8°
Pulse rate of rise	teach in

Measuring range	6-50 cm
Short-circuit proof	yes
Overload protection	yes
Reverse voltage protection	yes
Protection category	IP67
EMC-level	DIN EN 60947-5-7:2004-06
Housing material	Plastic
Termination	Connector M12 5pol

Errors and omissions excepted